

# LED PANEL LIGHT

595\*595\*35mm / 295\*1195\*35mm

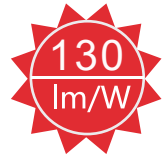

## Features:

- \*Super slim and efficient design
- \*High light efficient and energy saving
- \*Special heat treatment & Long life-span
- \*Environmental friendly

## Certificates:



# Technical Specification

**595\*595\*35mm**

Item	UL-PL6060-14W-TC	UL-PL6060-16W-TC	UL-PL6060-22W-TC	UL-PL6060-24W-TC	UL-PL6060-36W-TC
Power	14W	16W	22W	24W	36W
Lumen (±10%)	2100 LM	2400 LM	3300 LM	3600 LM	4680 LM
Lumen Efficiency	150LM/W				130LM/W
Voltage	AC220-240V ~ 50/60Hz				
CCT	4000K / 5000K				
PF	>0.9				
CRI	Ra > 80				
Beam Angle	120°				
Sensor	/				
Size (mm)	595*595*35mm				
Material	AL+PS				

# Packing information

Model No	Package	Size (MM)	QTY/PCS	Carton GW(KG)
UL-PL6060-14W-TC	Box size	620*255*625	6	10
UL-PL6060-16W-TC				
UL-PL6060-22W-TC				
UL-PL6060-24W-TC				
UL-PL6060-36W-TC				

# Technical Specification

## 1195X295X35mm

Item	UL-PL30120-14W-TC	UL-PL30120-16W-TC	UL-PL30120-22W-TC
Power	14W	16W	22W
Lumen (±10%)	2100 LM	2400 LM	3300 LM
Lumen Efficiency	150LM/W		
Voltage	AC220-240V ~ 50/60Hz		
CCT	4000K / 5000K		
PF	>0.9		
CRI	Ra > 80		
Beam Angle	120°		
Sensor	/		
Size (mm)	1195X295X35mm		
Material	AL+PS		

Item	UL-PL30120-24W-TC	UL-PL30120-36W-TC	UL-PL30120-40W-TC
Power	24W	36W	40W
Lumen (±10%)	3600 LM	4680 LM	5200 LM
Lumen Efficiency	150LM/W	130LM/W	
Voltage	AC220-240V ~ 50/60Hz		
CCT	4000K / 5000K		
PF	>0.9		
CRI	Ra > 80		
Beam Angle	120°		
Sensor	/		
Size (mm)	1195X295X35mm		
Material	AL+PS		

## Packing information

Model No	Package	Size (MM)	QTY/PCS	Carton GW(KG)
UL-PL30120-14W-TC	Box size	1220*255*325	6	10.5
UL-PL30120-16W-TC				
UL-PL30120-22W-TC				
UL-PL30120-24W-TC				
UL-PL30120-36W-TC				
UL-PL30120-40W-TC				

## Application

This product is suitable for office, hall, family, hotel, conference room, factory or office, commercial use, residential or public facilities, school, hospital lights.



## Dimension ( Unit : mm )

### Notes

- 1 . All dimension units are millimeters.
- 2 . All dimension to larence is  $\pm 0.5\text{mm}$  unless otherwise noted.

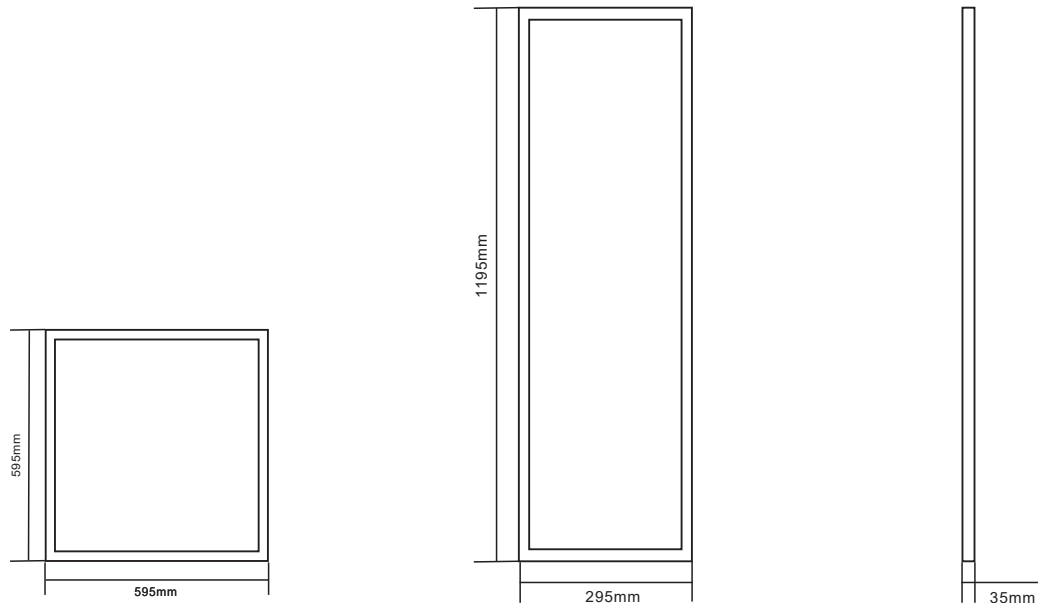

## Safety Information

- 1 . Please make sure cut off the power before installation.
- 2 . Please take care of water,electric shock and vibration.
- 3 . Please use the panel with standard working voltage,any other voltage is not allowed.
- 4 . Indoor use only.
- 5 . Please read this manual carefully before using.



# Installation

1.Recessed/Bult-in.Don't need any spare parts(Most Popular).

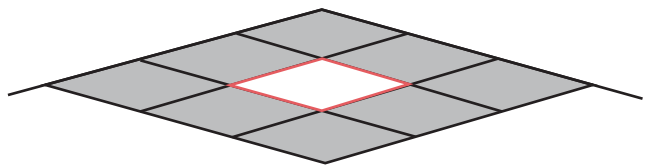
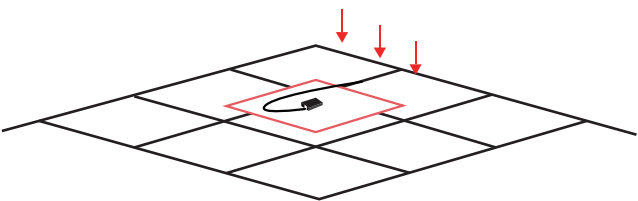
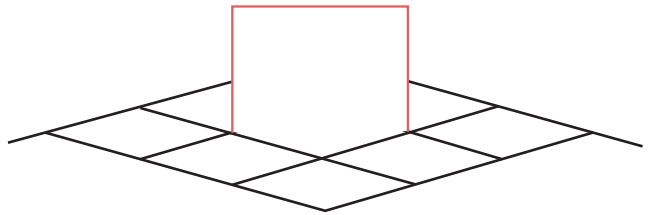
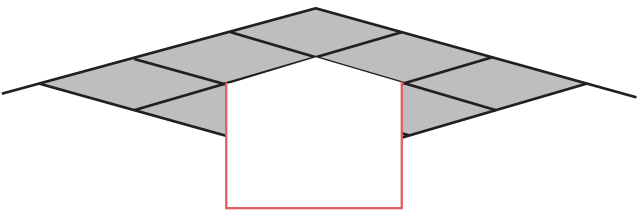
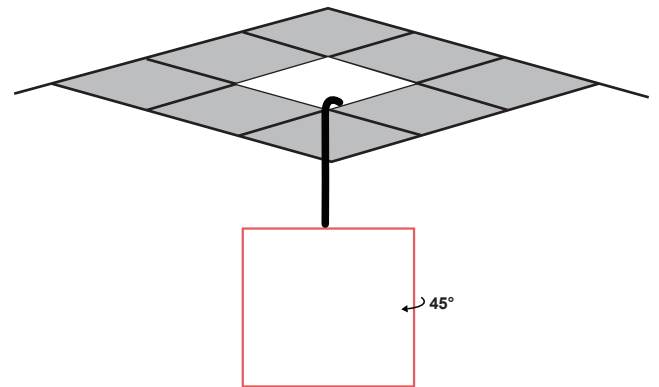
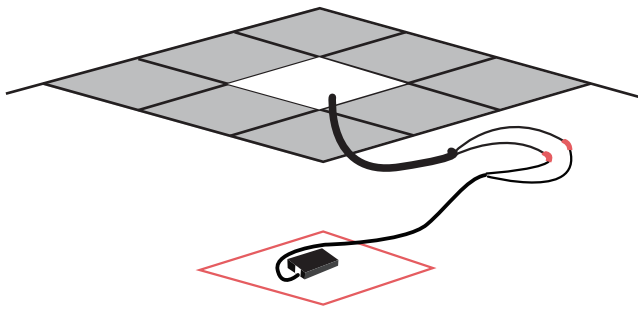

# Dimmer switch

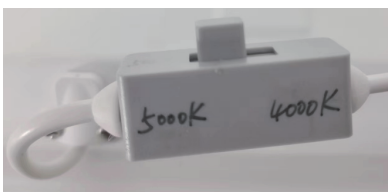

## Warning

- \*Please use the product within the specified Voltage range.
- \*Make sure power is switch off before installation.
- \*Ensure that the correct installation steps are followed.
- \*Installation to be done by a qualified electrician.
- \*If the external flexible cable or cord of this luminaire is damaged, it shall be exclusively replaced by the manufacturer or his service agent or a similar qualified person in order to avoid a hazard.
- \*The light source of this luminaire is not replaceable; when the light source reaches its end of life the whole luminaire shall be replaced.
- \*The minimum clearance distance from the all sides of the luminaire to any normally flammable building element or building insulation is 10cm.

**WARNING - RISK OF OVERHEATING OR FIRE IF THE CLEARANCE DISTANCES ARE COMPROMISED. THIS LUMINAIRE IS NOT SUITABLE FOR INSTALLATION IN LOCATIONS WHERE THERMAL INSULATION IS PRESENT, OR MAY REASONABLY BE EXPECTED TO BE INSTALLED IN THE FUTURE, OR WHERE THERE IS A LIKELIHOOD OF OTHER COMBUSTIBLE MATERIAL, E.G. LEAVES OR VERMIN DEBRIS, ETC. COLLECTING ON OR AROUND THE LUMINAIRE. IT IS NOT SUITABLE FOR DOMESTIC INSTALLATIONS OR INSTALLATION IN RESIDENTIAL AREAS OF NON-DOMESTIC INSTALLATIONS (RESIDENTIAL INSTITUTIONS, HOTELS, BOARDING HOUSES, HOSPITALS, ACCOMMODATION HOUSES, MOTELS, HOSTELS AND THE LIKE).**

